

Talis Select S

Basin mixer 100 with pop-up waste set

Surfaces: **Chrome** Article Number: **72042000**



Description

product features

- consists of: Basin mixer, waste set
- ComfortZone 100
- projection 93 mm
- normal spray
- flow rate at 3 bar: 5 l/min
- Select cartridge with temperature control
- temperature limitation adjustable
- suitable for continuous flow water heaters
- pop-up waste set G 1¼
- material waste set: metal
- connection type: G ¾ connections
- connection dimension: DN15

Technology



Product image



Scale drawing

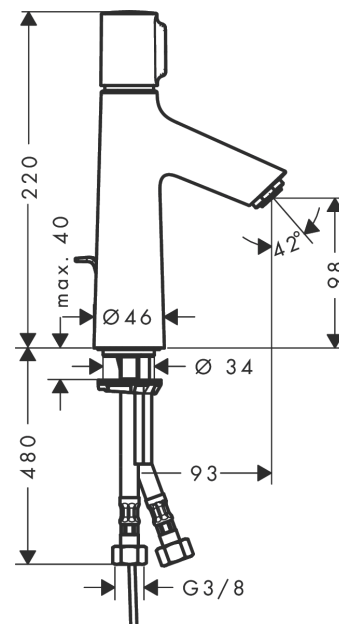

Flowchart

